

Dear customers

Thanks for purchasing our computer case. Please read through the entire manual before installation. If you received your case damaged, missing parts or having any other questions, please feel free to email us at support@mydiypcusa.com.

Warning

Installation must be performed with power supply off at all time, otherwise electrical damage on the computer case may occur. Please double check on all the connections before turning on the power supply for testing.

General information of DIYPC support

We provide 1 year manufacturer warranty on all computer cases we sell, for all the components, including all the electronic parts such as fans, audio jet, power switch etc. But we do not cover shipping damage or physical damage or any wear and tear, or any damage due to installation, or any damage due to improper usage.

ACCESSORIES

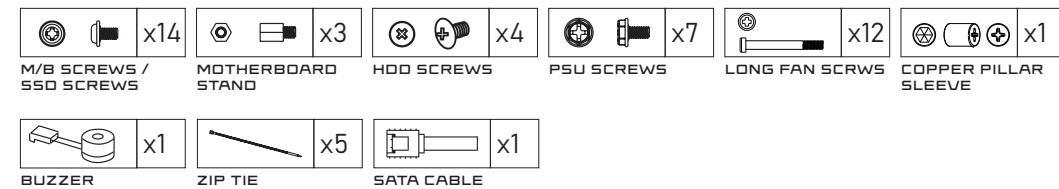

FANS ASSEMBLING

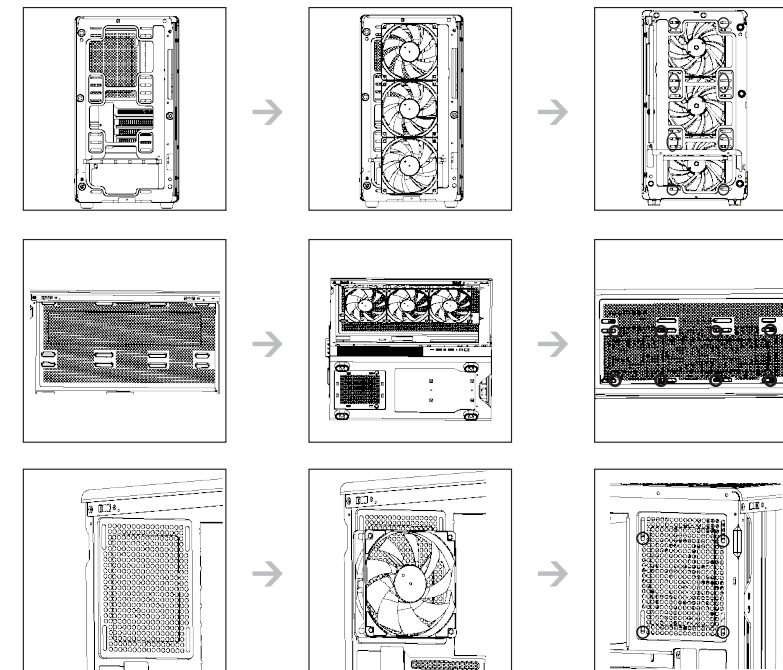

RADIATOR ASSEMBLING

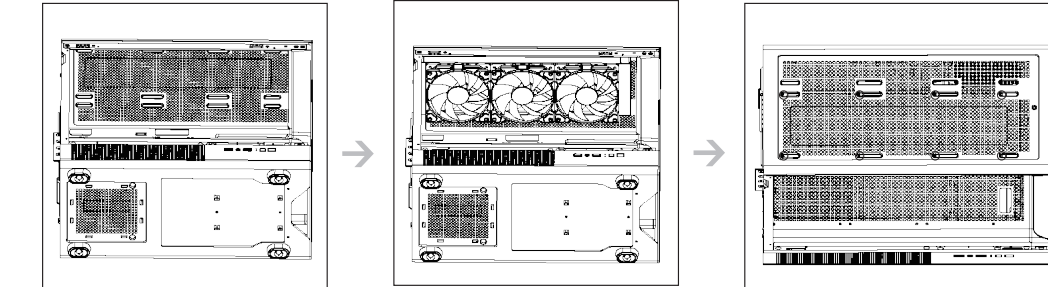

PSU ASSEMBLING

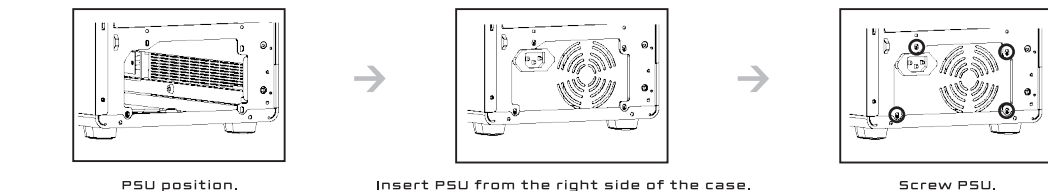

MOTHERBOARD ASSEMBLING

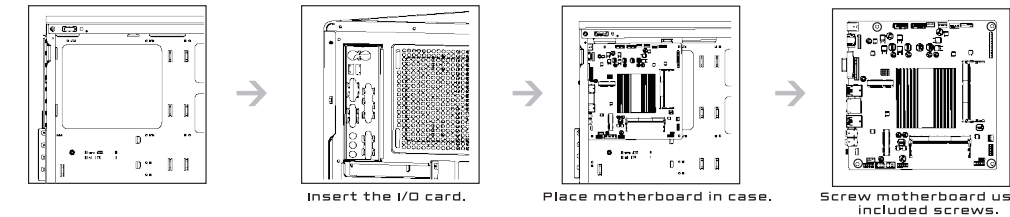

GRAPHICS CARD ASSEMBLING

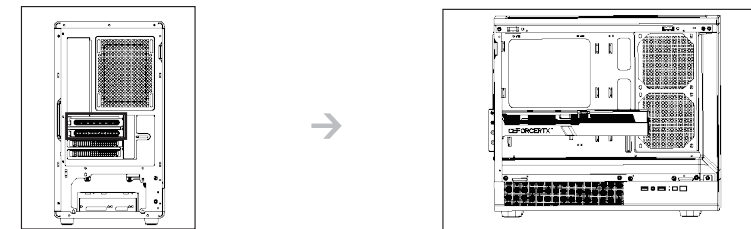

3.5" HDD / 2.5" SSD ASSEMBLING

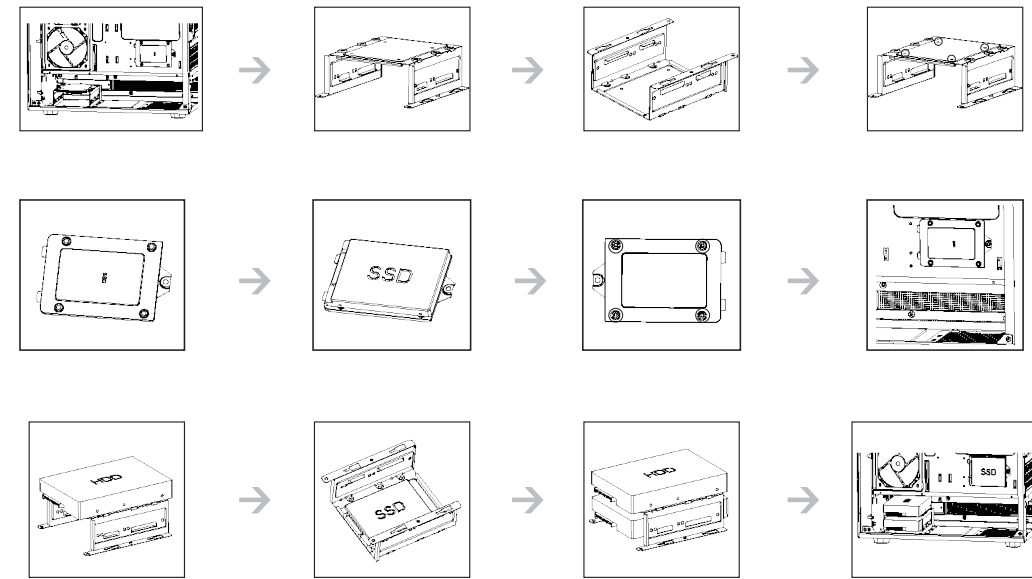

CABLE CONNECTION

Please refer to the manual that came with your motherboard for any specific connection instructions.

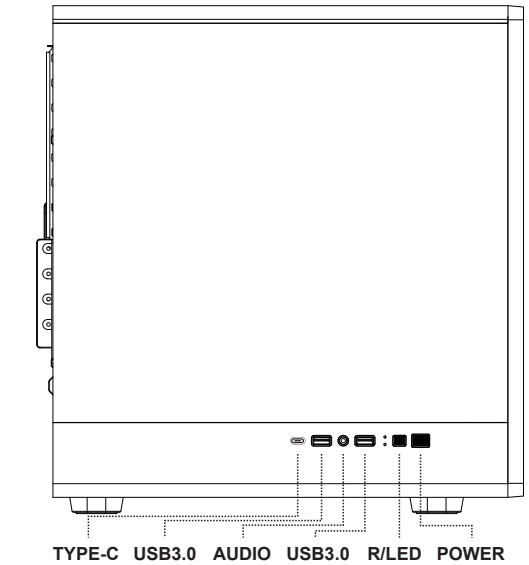

Schematic diagram of wire interface

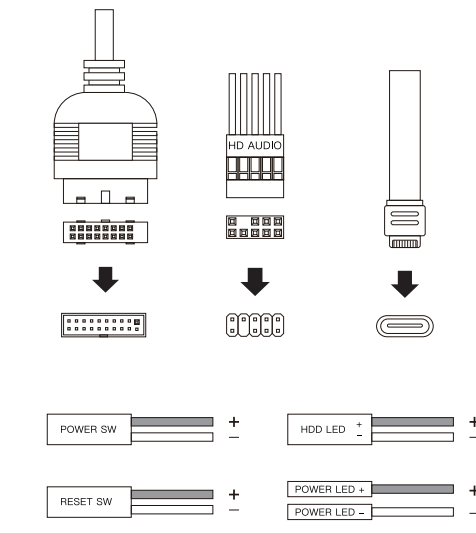

SATA CONNECT TO PSU

